

Features:

- n Isolated mounting base 3000V~
- n Pressure contact technology with Increased power cycling capability
- n Space and weight saving

Typical Applications

- n Various rectifiers
- n DC supply for PWM inverter

V _{RRM}	Type & Outline
800V	MDx182-08-216F3
1000V	MDx182-10-216F3
1200V	MDx182-12-216F3
1400V	MDx182-14-216F3
1600V	MDx182-16-216F3
1800V	MDx182-18-216F3
1800V	MD182-18-216F3G

MDx stands for any type of **MDC, MDA, MDK**

SYMBOL	CHARACTERISTIC	TEST CONDITIONS	T _J (°C)	VALUE			UNIT
				Min	Type	Max	
I _{F(AV)}	Mean forward current	180° half sine wave 50Hz Single side cooled, T _C =100°C	150			182	A
I _{F(RMS)}	RMS forward current					286	A
I _{RRM}	Repetitive peak current	at V _{RRM}	150			12	mA
I _{FSM}	Surge forward current	V _R =60%V _{RRM} , t=10ms half sine.	150			6.4	kA
I ² t	I ² t for fusing coordination					205	10 ³ A ² s
V _{FO}	Threshold voltage		150			0.80	V
r _F	Forward slope resistance					0.96	mΩ
V _{FM}	Peak forward voltage	I _{FM} =550A	25			1.43	V
R _{th(j-c)}	Thermal resistance Junction to case	Single side cooled per chip				0.22	°C/W
R _{th(c-h)}	Thermal resistance case to heatsink	Single side cooled per chip				0.08	°C/W
V _{iso}	Isolation voltage	50Hz, R.M.S, t=1min, I _{iso} :1mA(MAX)		3000			V
F _m	Terminal connection torque(M6)			4.5		6.0	N·m
	Mounting torque(M6)			4.5		6.0	N·m
T _{vj}	Junction temperature			-40		150	°C
T _{stg}	Stored temperature			-40		125	°C
W _t	Weight				320		g
Outline	216F3						

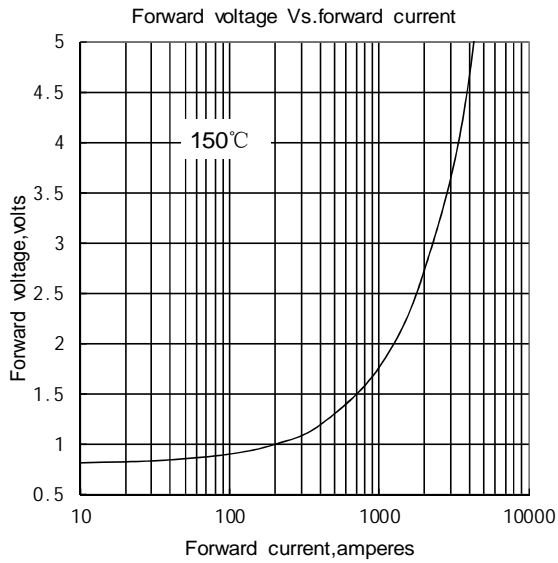

Fig.1

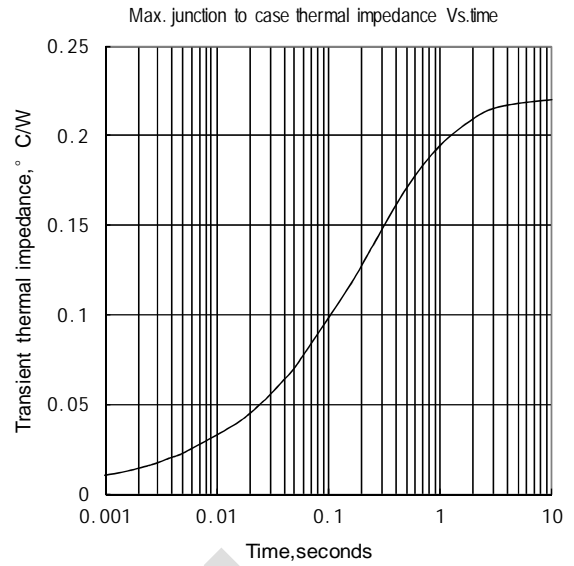

Fig.2

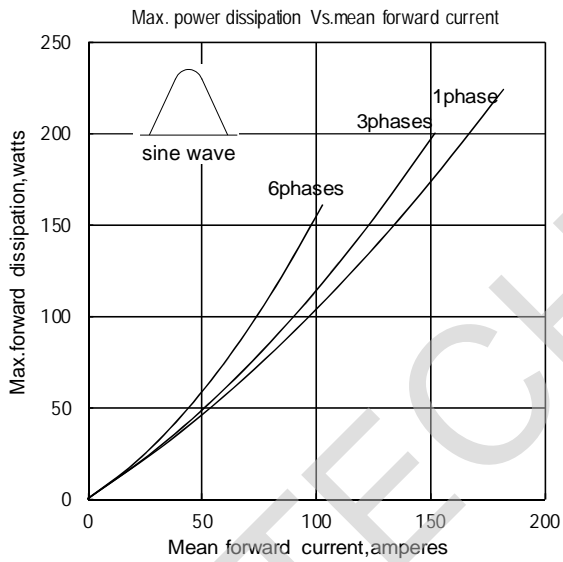

Fig.3

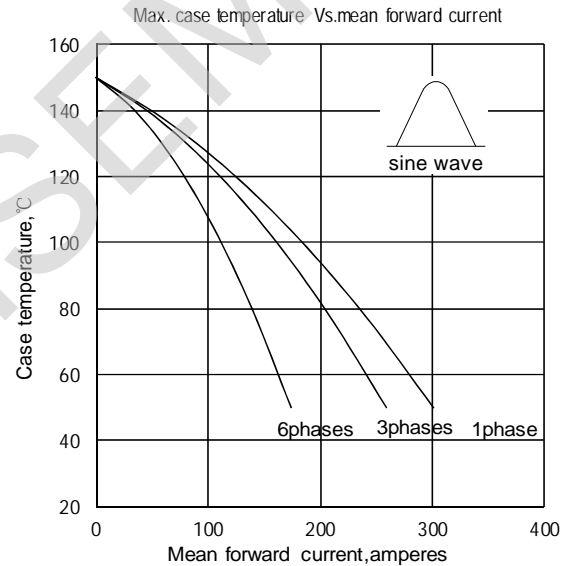

Fig.4

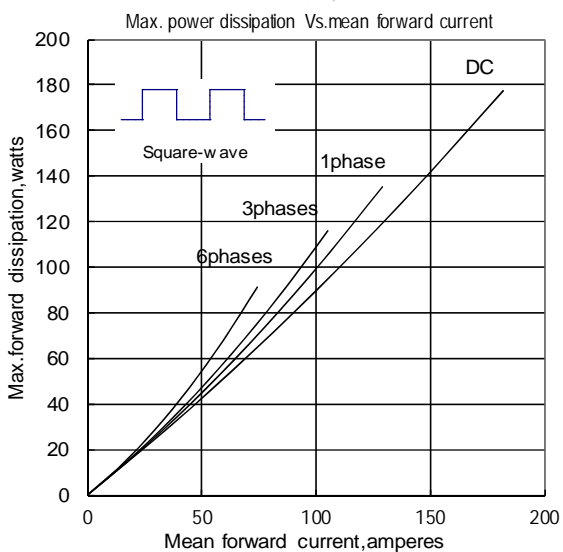

Fig.5

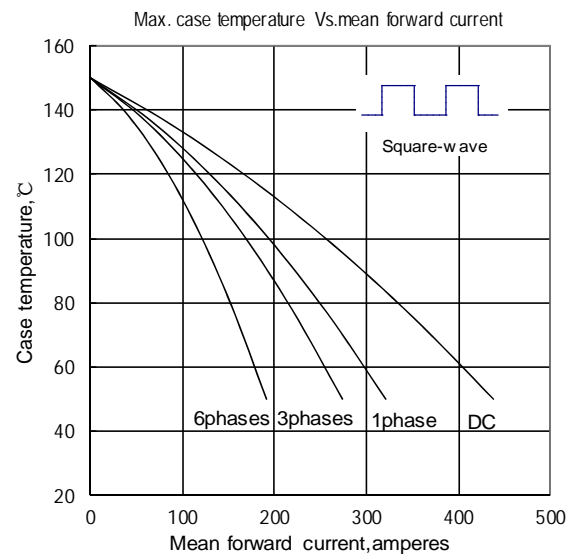

Fig.6

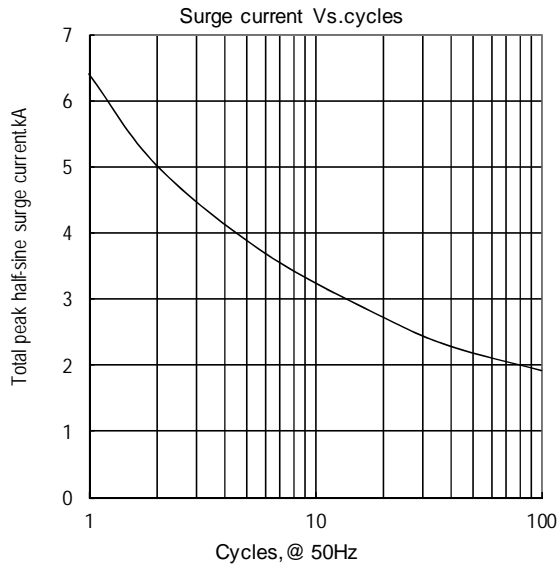

Fig.7

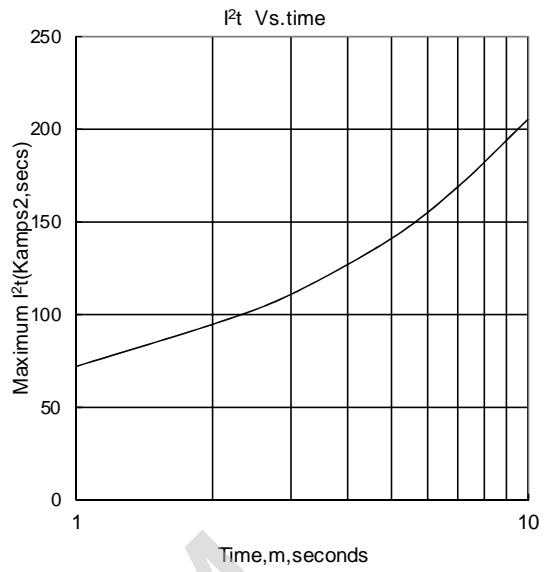
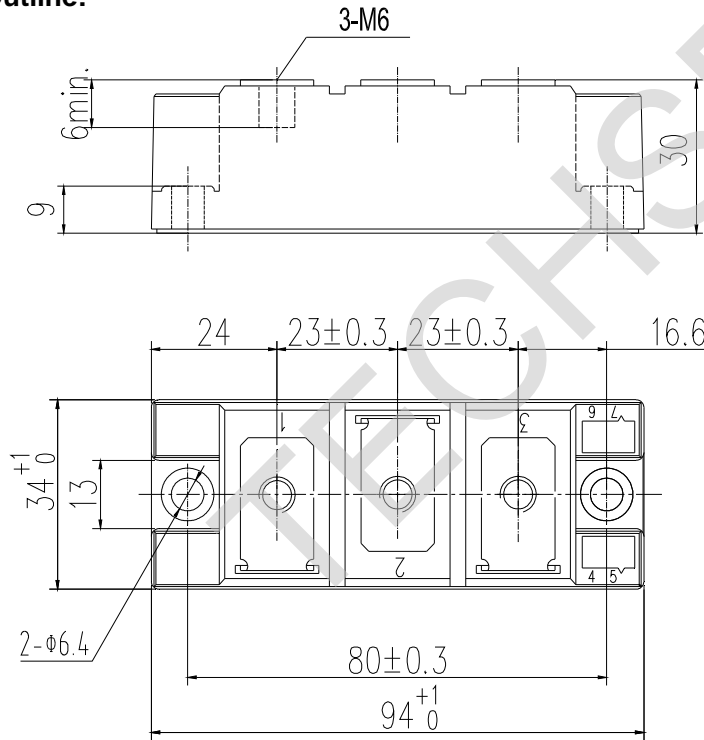

Fig.8

Outline:



Unmarked dimensional tolerance: ±0.5mm

